

Remote Control Pulse Valve - PL1020 Series (G3/4", G1")

GENERAL FEATURES

- The pulse valves are especially used for dust collector service application or similar systems.
- Compact design, high reliability, flow rate, quality and performance; long life.
- Extremely fast opening and closing
- Working Temperature: -20°C ... 80°C
- On request; with electronic timer
- Some application; dust filters, bunkers, dust extractors, electrostatic painting cabinets.
- Pulse valves must be used with filtered fluids.

MATERIALS IN CONTACT WITH FLUIDS

Body	: Aluminium
Internal Parts	: Stainless Steel
Sealing	: Thermoplastic
Shading Ring	: Copper
Seats	: Aluminium
Core, Tube	: Stainless Steel
Spring	: Stainless Steel
Response Time	: Opening Time : 100 ms Closing Time : 100 ms

2/2 WAY

PILOT OPERATED

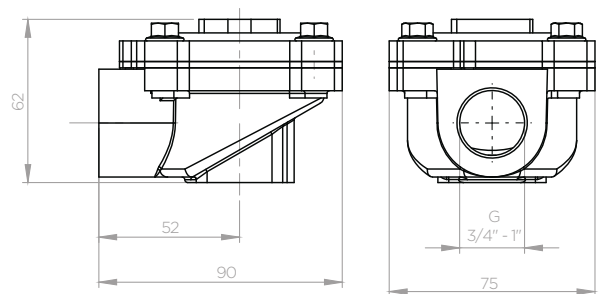
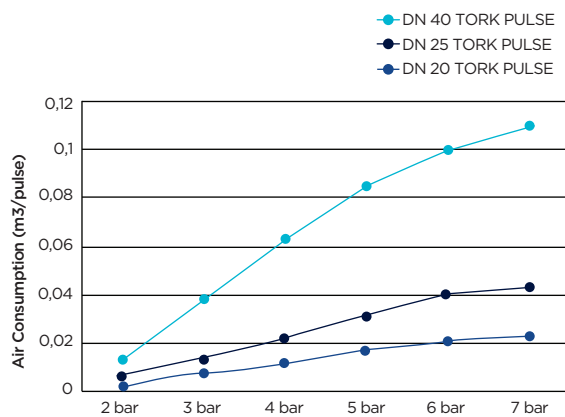
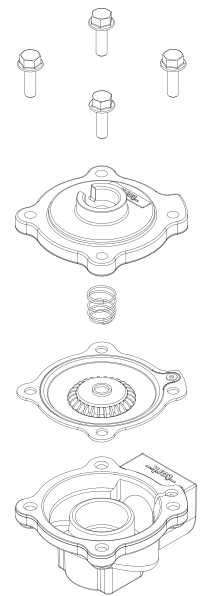
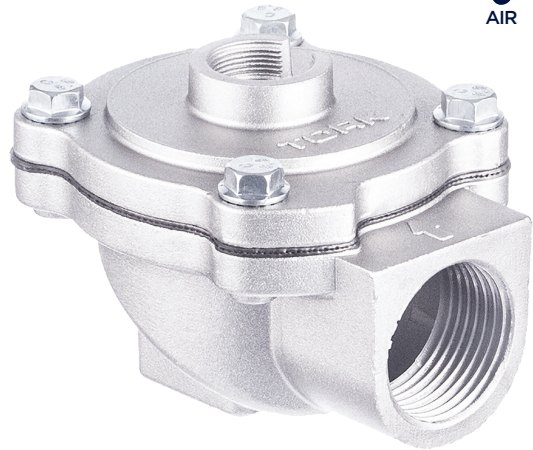

Valve Order No	Connection Size	Orifice Size	Pressure		Fluid Temperature		Seal	Weight
			min	max	min	max		
PL 1010	G	mm	bar	bar	°C			(kg)
PL1020.04 - P	3/4"	25	0.5	8	-20	80	Thermoplastic	0.44
PL1020.05 - P	1"	25	0.5	8	-20	80	Thermoplastic	0.43

• TORK Pulse Valves comply with 97/23 / EC, Pressure Equipment Directive (PED) and Low Voltage Directive 2006/95 / EEC.
 • Standard pipe connection GIBSP (ISO 228-1) is available on request. Other pipe connections can also be made on request. ((NPT) ANSI 1, 20, 31)

Remote Control Pulse Valve - PL1020 Series (G1 1/2", G2", G2 1/2", G3")

GENERAL FEATURES

- The pulse valves are especially used for dust collector service application or similar systems.
- Compact design, high reliability, flow rate, quality and performance; long life.
- Extremely fast opening and closing
- Working Temperature: -20°C ... 80°C
- On request; with electronic timer
- Some application; dust filters, bunkers, dust extractors, electrostatic painting cabinets.
- Pulse valves must be used with filtered fluids.

MATERIALS IN CONTACT WITH FLUIDS

Body	: Aluminium
Internal Parts	: Stainless Steel
Diyafram	: Thermoplastic (1 1/2"), Reinforced Rubber (2", 2 1/2", 3")
Shading Ring	: Copper
Seats	: Aluminium
Core, Tube	: Stainless Steel
Spring	: Stainless Steel
Response Time	: Opening Time : 100 ms Closing Time : 100 ms

2/2 WAY

PILOT OPERATED

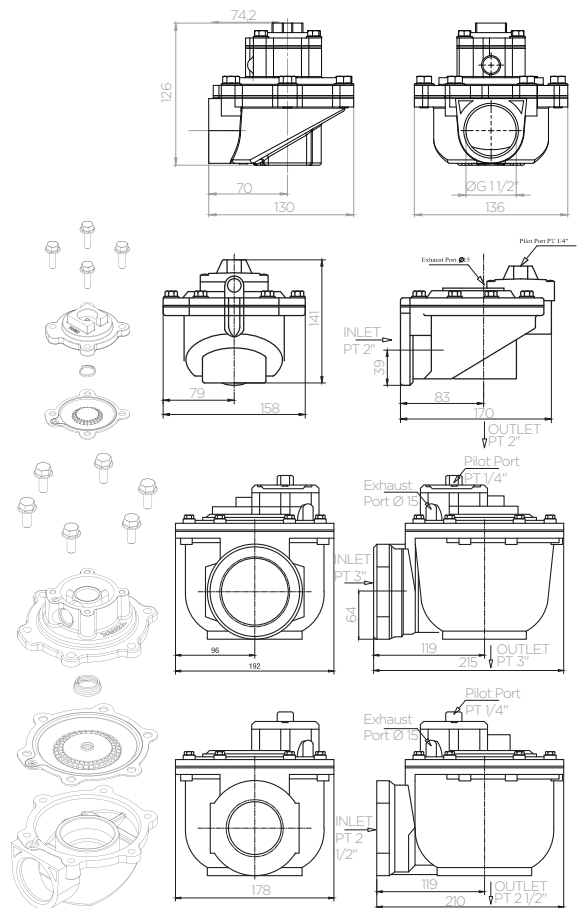
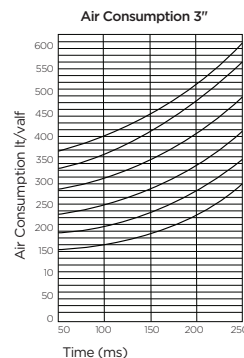
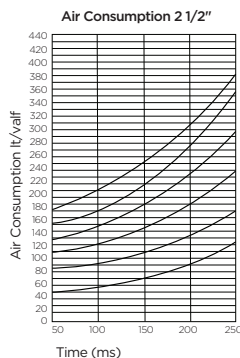
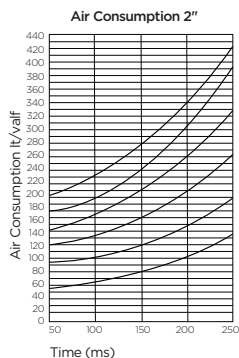
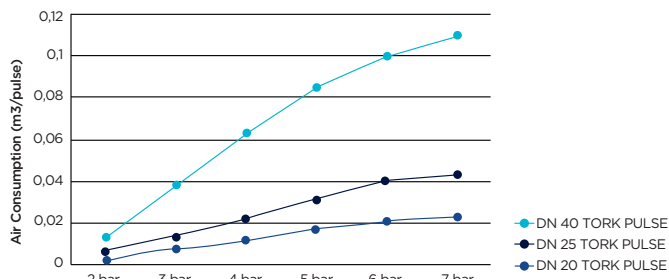
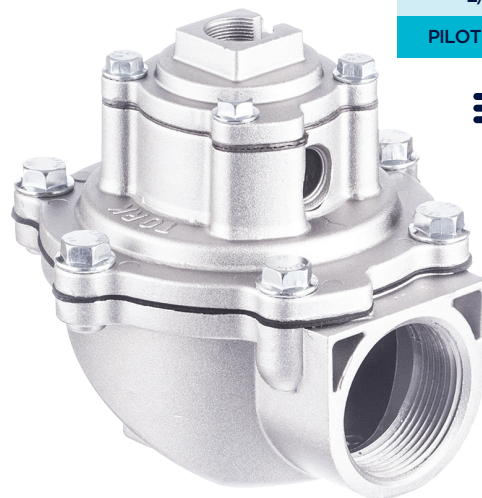

Valve Order No	Connection Size	Orifice Size	Pressure		Fluid Temperature		Seal	Weight
			min	max	min	max		
PL 1020	G	mm	bar	bar	°C			(kg)
PL1020.07 - P	1 1/2"	44	0.5	8	-20	80	Thermoplastic	1.04
PL1020.08	2"	50	0.5	8	-20	80	Reinforced Rubber	1.9
PL1020.09	2 1/2"	65	0.5	8	-20	80	Reinforced Rubber	3.3
PL1020.10	3"	80	0.5	8	-20	80	Reinforced Rubber	3.5

• TORK Pulse Valves comply with 97/23 / EC, Pressure Equipment Directive (PED) and Low Voltage Directive 2006/95 / EEC.
 • Standard pipe connection GIBSP (ISO 228-1) is available on request. Other pipe connections can also be made on request. ((NPT) ANSI 1, 20, 31)